

WeatherTech®

Easy-On™ Stone & Bug Deflectors

Important Safety Information



- CAUTION - Before driving, ensure that the hood shield is properly secured to vehicle.
- Do not use automatic "brush-style" car washes.
- Do not use cleaning solvents of any kind.
- Periodically check all components for tightness.

Contents

NOTE: Actual product may vary from illustration.



Hood shield



Bump On
x4



Alcohol
Pad x2

Tools Required



Car Wash Supplies

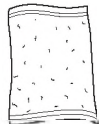

Clean Towel

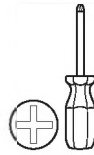

Phillips
screwdriver

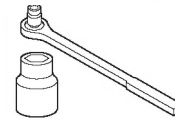

Socket
wrench

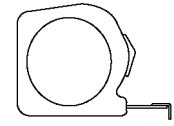

Tape measure

Preparation Before Painting / Installation

- A trial fit is recommended to ensure proper positioning and fit.
- Check fit of parts before painting as we will not accept the return of modified or painted parts.
- Wash and dry your vehicle to remove any debris and/or dirt from the installation area.

Installation Steps

NOTE: Actual application may vary slightly from illustrations.

Open hood.

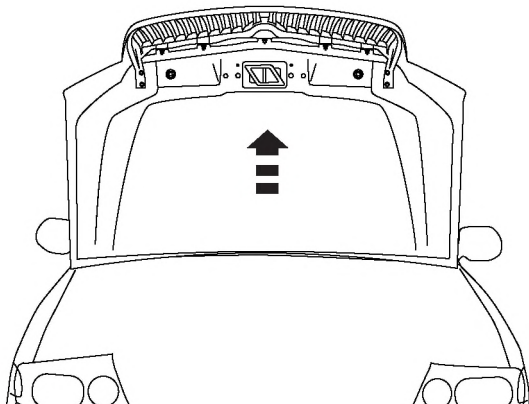

1



Loosen (5) nuts and (4) screws that attach grill to hood.

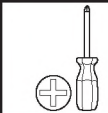

2

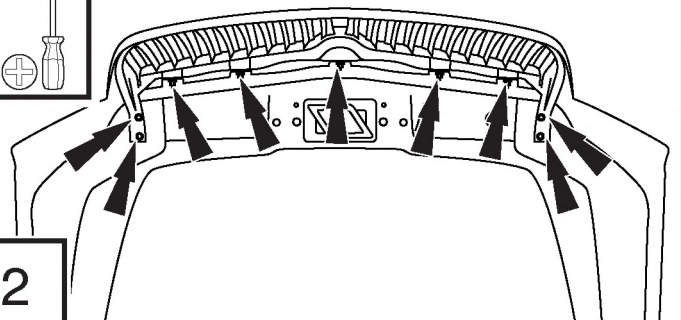

Installation Steps

NOTE: Actual application may vary slightly from illustrations.



Lower hood, and create a 1/4" (.64 cm) gap between the grill and the hood.

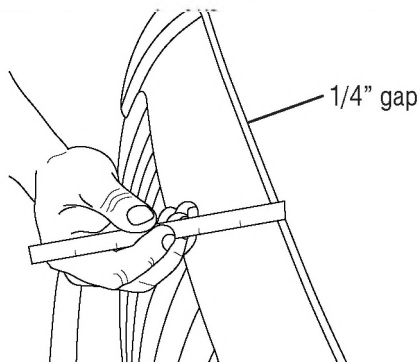

3



Clean the tape mounting locations on both ends of the hood with an alcohol pad.

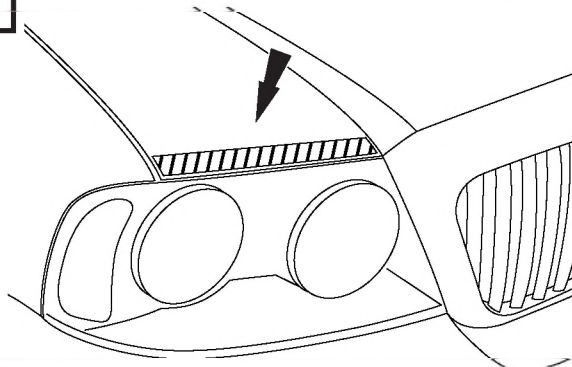

4

Expose 2" (5 cm) of tape liner from each end of the flanges on the hood shield.

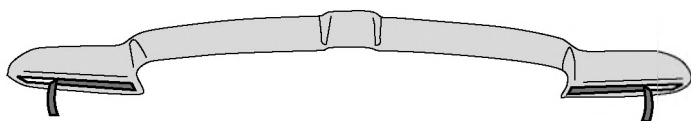

5



Install bump ons at pre-cleaned locations on both sides of the hood and front fenders.

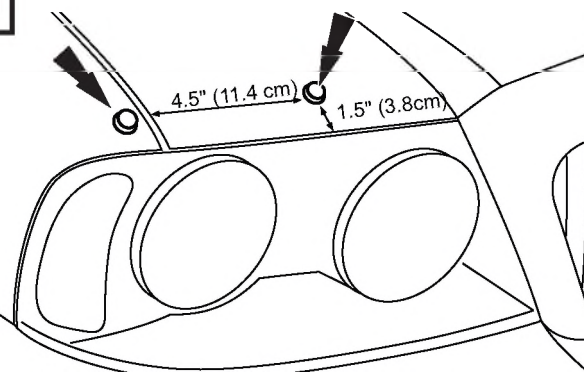

6

Align the hood shield center point with the center of hood. Slide hood shield into created gap between grill and hood. Press on exposed tape to secure position.

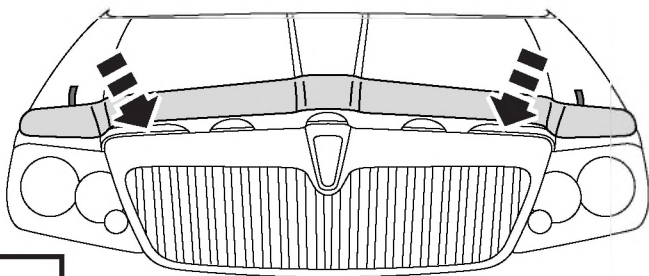

7



Raise hood and retighten the (5) grill nuts and (4) grill screws.

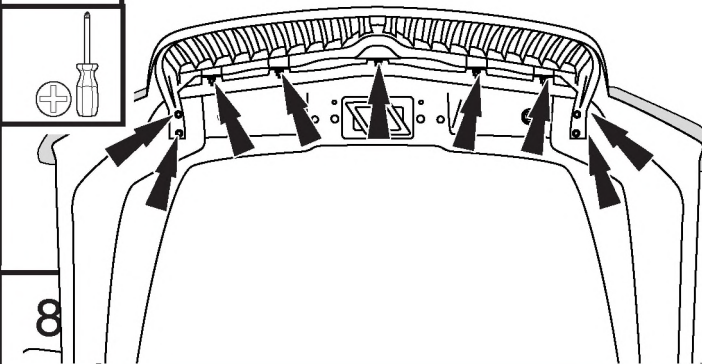

8

With the hood shield in its final position, remove the remaining tape liner by pulling on free ends.

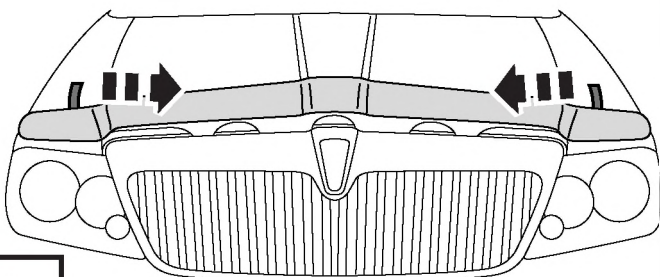

9



Apply pressure to taped areas to ensure adhesion.

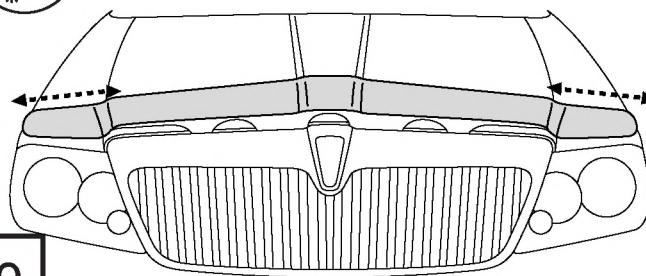

10

Care and Cleaning

- Wash only with mild soap & dry with a clean cloth.



1 MacNeil Ct.

Bolingbrook, IL 60515

Questions? Call customer service @ 630.769.1500

Monday - Friday, 9 a.m. to 5 p.m. Central Time

www.WeatherTech.com